

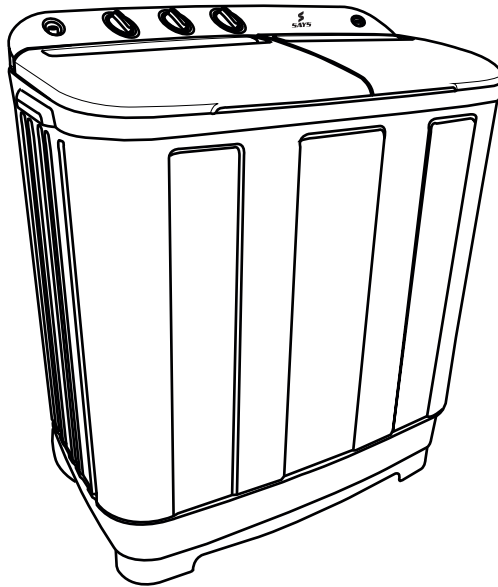

USER MANUAL
DOUBLE TUB SEMI-AUTOMATIC
WASHING MACHINE
WSA-7500KLW

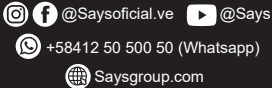

Learn more about us
Follow us!



Please, read carefully this manual before to use this unit.
Keep safe this manual for future references.

CONTENTS

Before Using The Machine

Introduction To Parts	1
Point Of Attention	2

In Operation

Preparation Before Wash	3
Washing Procedure	4 & 5
Maintenance	6 & 7
Troubleshooting	8
Warranty & costumer service	9

BEFORE USING THE MACHINE INTRODUCTION TO PARTS

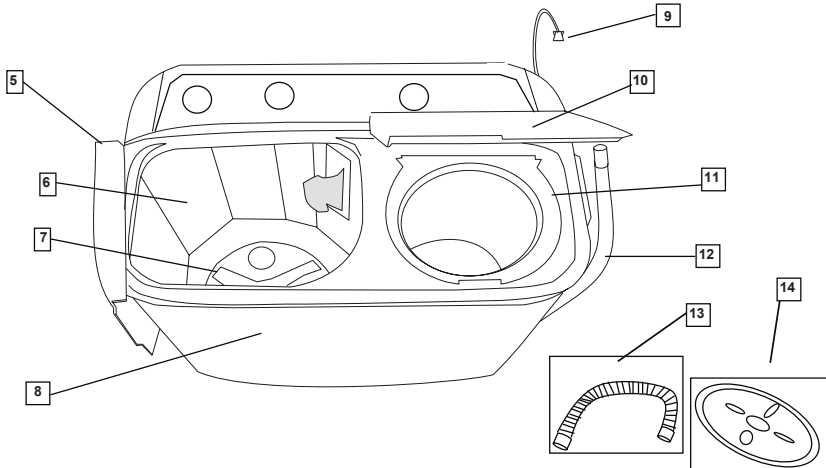
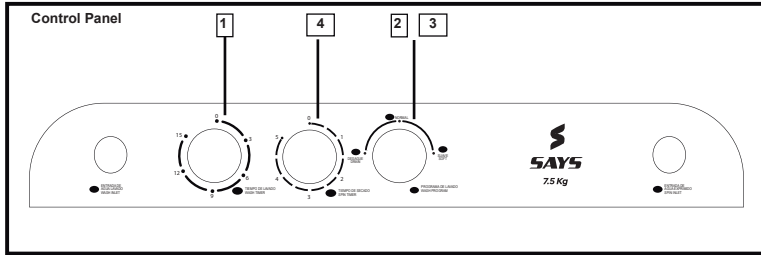

NO	PART NAME
1	Wash Timer
2	Wash Program
3	Wash/Drain Selector
4	Spin Timer
5	Wash Cover
6	Wash Tub
7	Pulsator
8	Outer Body
9	Power Cord
10	Spin Cover

NO	PART NAME
13	Spin Inner Cover
14	Drain Hose
15	Water Inlet Hose
16	Spinning pressing board

POINT OF ATTENTION

<p>*In case the plug top of the power supply cord is damaged , user should not attempt to fix it without electrical knowledge. Seek advise from expert or contact qualified technician.</p>	<p>*Do not share one power outlet with other electrical appliances. Do not use unappointed power source. Keep the plug strip clean.</p>
<p>*Forbid children from playing near the machine.</p>	<p>*Never put your hand in the tub while it's running.</p>
<p>*Keep machine away from heat-generating equipment. * Avoid from direct sunlight.</p>	<p>*Do not place the machine in the bathroom. Such action may damage the electrical insulation and cause body rust.</p>
<p>*Do not put heavy or hot things on top of the machine.</p>	<p>*Do not wash waterproof clothes like rain-coat. Abnormal vibration may occur in spin tub.</p>
<p>*Do not wash laundry soaked with petrol and organic solvent.</p>	<p>*Place machine on flat and solid ground.</p>

1. The appliance is not intended for use by persons (including children) with reduced physical, sensory or mental capabilities, or lack of experience and knowledge, unless they have been given supervision or instruction concerning use of the appliance by a person responsible for their safety.
Children should be supervised to ensure that they do not play with the appliance.
2. If the supply cord is damaged, it must be replaced by the manufacturer, its service agent or similarly qualified persons in order to avoid a hazard.
3. The new hose-sets supplied with the appliance are to be used and that old hose-sets should not be reused.
4. Water Pressure: 0.1MPa ~ 2.0Mpa

IN OPERATION

PREPARATION BEFORE WASH

- 1) Set the drain hose to drainage.
- 2) Plug the power supply cord plug top into a 3 pin core power .
- 3) Insert the water inlet hose into water inlet connector.

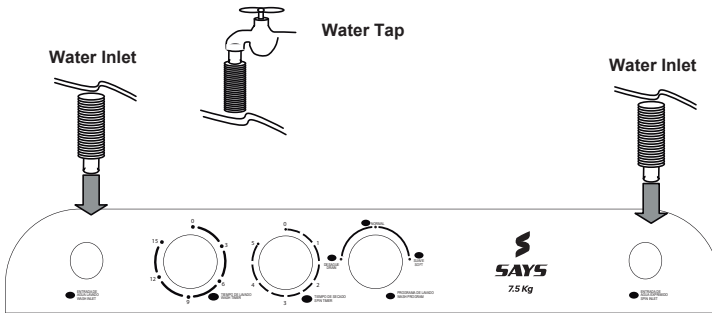

- 4) Select the water level according to the quantity of laundry by referring to water level marking.

WASHING PROCEDURE

A) Washing



1) Water Inlet

Select the water level to the desired position.

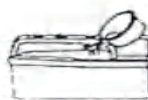

2) Add in water and dissolved detergent to make the water reach the expected level. Operate the machine to stir the detergent evenly by turning the Wash Knob.

3) Put in laundry.

4) Select wash duration according to the weight of laundry.



5) Select washing type (Normal/Stronger) according to the weight of laundry.

6) After each washing operation end's , set the Wash Selector to Drain.



7) Washing capacity: 7.5kg

B) Intermediate -Spin (Removing Detergent/Dry)

1) Move laundry from wash tub to spin tub.

2) Spin to remove dissolved detergent

a) Arrange laundry uniformly in the spin tub without stacking them all on one side.

An unbalance spin tub may cause abnormal vibration and noise.

b) Press the laundry down firmly and place the spinner cap on top of them.

c) After rinsing, close the outer cover of the spin tub and spin for 1 minute.

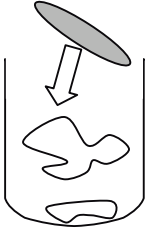

Place Spinner Cap

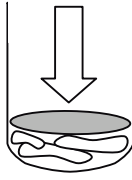

Press down firmly



Do not stack the laundry one side

3) Soak Rinse

- i) Place the laundry into the wash tub, and then select suitable washing type.
- ii) Select the water level . (Select the water level according to the amount of laundry)
- iii) Rinse :- Set the timer to 0 - 5 minutes and let it rinse.

4) Dry Spin

- i) Arrange laundry uniformly in the spin tub without stacking them all on one side.
An unbalance spin tub may cause abnormal vibration and noise.
- ii) Press the laundry down firmly and place the spinner cap on top of them.
- iii) Select suitable spinning duration according to the quantity of laundry.
(1 minute,3 minutes,5 minutes)

5) Spin capacity: 5.5kg

- * **An unbalance spin tub may cause abnormal vibration or noise.If such incident occur, open the cover of the spin tub and rearrange the laundry, then continue the spinning operation.**

MAINTENANCE

Please unplug the power supply cord before performing any disposal .
There will be lint left behind in the overflow filter and the lint filter after each time of used.
These filters need to be cleaned frequently in order to maintain the top performance of the machine.

Clean of the entire machine

- * Clean the machine with a soft damp cloth.
- * Do not spray water directly onto the machine.
- * If the machine is too dirty , add neutral detergent to clean.
- * Do not use petroleum-based detergent to clean the machine , as this will spoil the appearance.



Cleaning of the overflow filter (Optional)

* Please clean the filter at least once in 2 months.

1) Dismantling of the overflow filter

Pinch the flexible-fastening claw , pull it gently away from machine as shown in picture.

2) Dismantling the bellows

Open the back cover of the filter as shown in the picture,
Clean the filter completely under running water.

3) Cleaning the overflow filter

Clean the filter completely under running water.



4) Installing the overflow filter

- * Install the bellows.
- * Insert the tie plate of the bottom of valve cover.
- * Put up the hook at the left top.
- * Press the top to the slot as shown in picture.

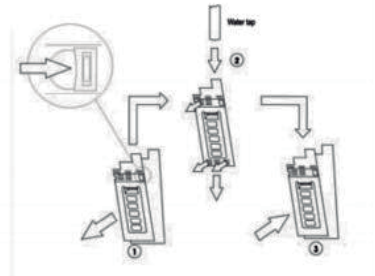

Cleaning the lint filter

- * The lint filter must be used during each time of washing.
- * The lint filter must be cleaned immediately each time after use.

1) Dismantling the lint filter

Hold the filter frame as shown in picture , gently press downward and pull off from the filter frame.

2) Cleaning the filter

Wash the filter while it is still wet. Wash only with plain water. After wash , dry it. Avoid from drying under direct sunlight .

3) Installing the filter

Insert the bottom part of the filter frame into the slot, and then gently push the filter in place.

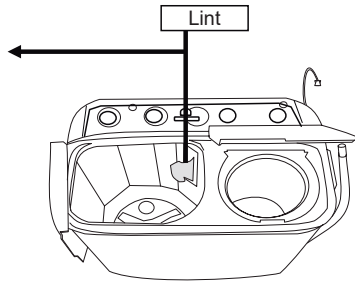
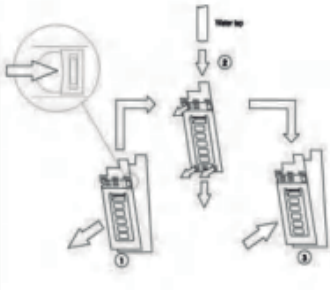

TROUBLESHOOTING

Before you call for technician or send your machine for repair, please check from this troubleshooting list :

* Do not attempt to repair the machine by yourself .

Phenomena	Possible Causes
The machine does not work.	<ul style="list-style-type: none"> * Is the power cut ? * Is the power supply cord connected to a power outlet ? * Is the pulsator tangle with something ?
Unable to drain. Abnormal sound while washing.	<ul style="list-style-type: none"> * Has the drain hose being lowered ? * Is the drain hose frozen ? * Is the drain hose blocked ? * Are there any clothes fallen outside of the spin tub ? * Are there any loose articles in the wash tub ?
Water in the wash tub reduced.	<ul style="list-style-type: none"> * Is the bellows of the overflow filter being miss-installed ?
There is abnormal sound and violent vibration while spinning.	<ul style="list-style-type: none"> * Is the machine place on a flat and solid ground ? * Is the spinner cap being placed into the spin tub ? * Are there any clothes fallen outside of the spin tub ? * Are there too many laundry in the spin tub ?

Warranty and customer service

The warranty does not apply in case of:

- Normal wear and tear of the product.
- Improper use, for example, overloading the device and the use of non-approved accessories.
- If the product has been tampered with; damaged, repaired by unauthorized persons or any wrong use.
- Does not apply if there was use of force or any damage caused by external or internal influences.
- Damage caused by non-observance of the instruction manual, for example, connection to a network improper power supply or failure to follow installation instructions.
- Device partially or totally dismantled.
- This warranty is limited to manufacturing defects.

Please attach your sales receipt to this manual and save it for future use if needed.

Proof of purchase is required under these warranty conditions.

Warranty and more information please contact us at:

 atencion@saysgroup.com

 +58412 50 500 50 (Whatsapp)

 0501-SAYS501 (0501-7297501)

 Saysgroup.com

PERSONALIZED ATTENTION

**INSURED
WARRANTY**